

# ASSEMBLY INSTRUCTION

## POWERS

4 DOOR BUFFET

ITEM CODE 84214

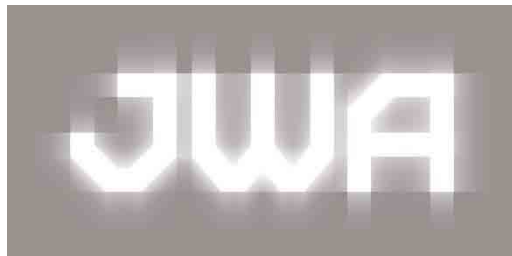
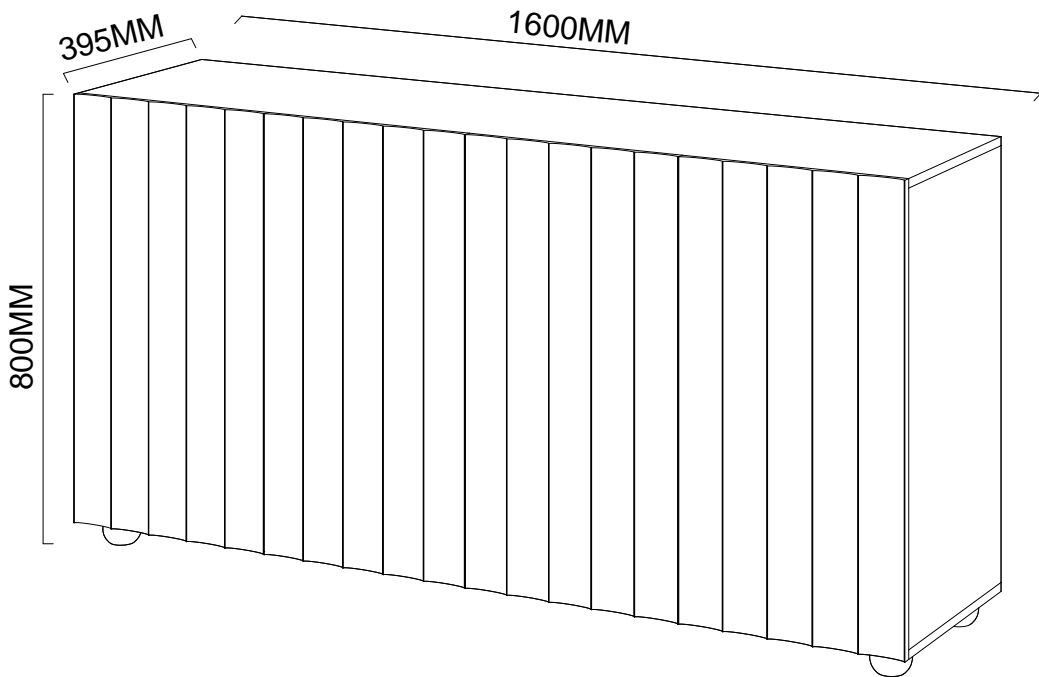

Imported by JWA Furniture Pty Ltd, Qld, Brisbane Australia.  
For any assistance with assembly or for missing parts please refer to your receipt

## PRE-ASSEMBLY PREPARATION

### Before you start:

1. Choose a clean, level, spacious assembly area. Avoid hard surfaces that may damage the product
2. Take care when lifting. Product should be assembled as near as possible to the point of use
3. Ensure that you have all required contents for complete assembly
4. Always read the assembly instructions carefully before beginning assembly.
5. Keep all hardware parts and packaging out of reach of small children.
6. Do not over tighten the screws and bolts as this may damage the threads

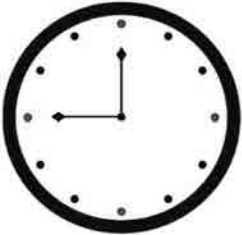
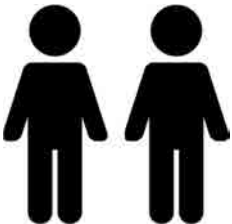
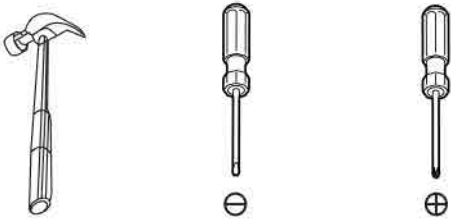
		
Allow 45 min	For 2 person	Additional tools required







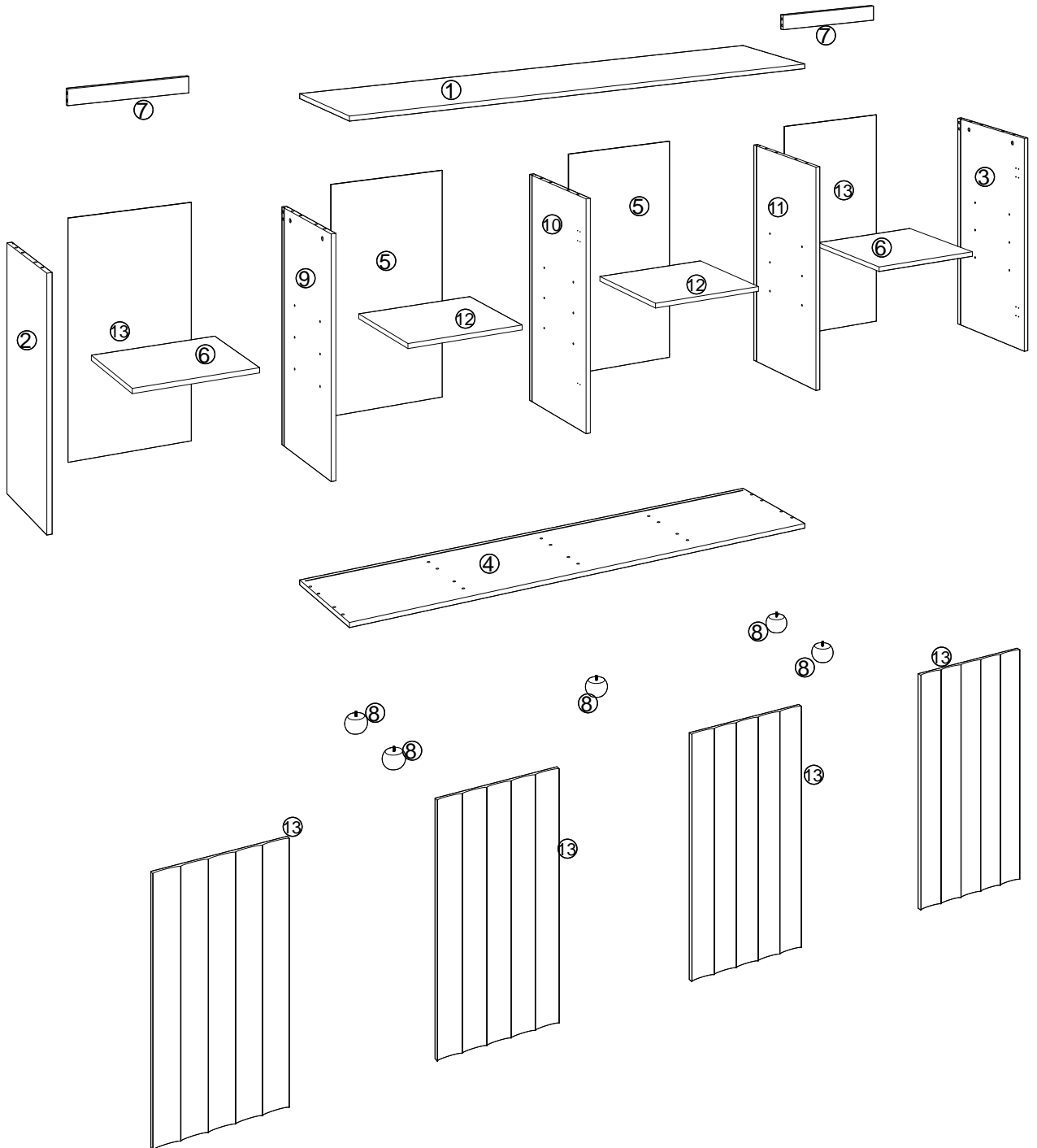



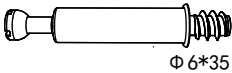
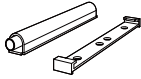

# ⚠ WARNING

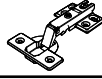
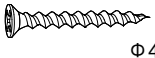
		<p><b>Children have died from furniture tipover.</b></p> <ul style="list-style-type: none"><li>• ALWAYS secure it with an anchor device.</li><li>• NEVER allow children to stand, climb or hang on drawers, doors, or shelves.</li><li>• NEVER open more than one drawer at a time.</li><li>• Place heavy items down low</li></ul> <p><b>NEVER put a TV on this furniture</b> </p> <p style="color: red; font-size: small;">This is a permanent label. Do not remove!</p>
---	---	--

# PARTS LIST

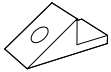

## PARTS LIST

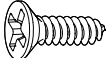
NO.	ITEM	QTY	NO.	ITEM	QTY
A	 Φ 6*35	18PCS	I		4PCS
B	 Φ 15*10	18PCS	J		4PCS
C	 Φ 8*30	20PCS	K		4PCS
D	 Φ 4*35	10PCS	L	 Φ 3.5*14	48PCS
E		2PCS	M		16PCS
F		16PCS	N		10PCS
G	 Φ 3*16	16PCS	O		5PCS
H	 Φ 3*12	8PCS			

NO.	ITEM	QTY	NO.	ITEM	QTY
①	TOP PANEL	1 PC	⑨	LEFT MIDDLE PANEL	1 PC
②	LEFT SIDE PANEL	1 PC	⑩	MIDDLE PANEL	1 PC
③	RIGHT SIDE PANEL	1 PC	⑪	RIGHT MIDDLE PANEL	1 PC
④	BOTTOM PANEL	1 PC	⑫	SHELF PANEL	2 PCS
⑤	BACK PANEL	2 PCS	⑬	DOOR PANEL	4 PCS
⑥	SHELF PANEL	2 PCS			
⑦	MIDDLE SUPPORT PANEL	2 PCS			
⑧	LEG	5 PCS			

# STEP 1:

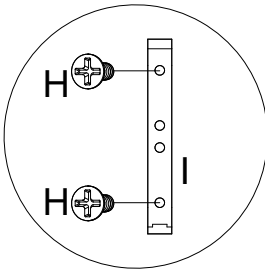
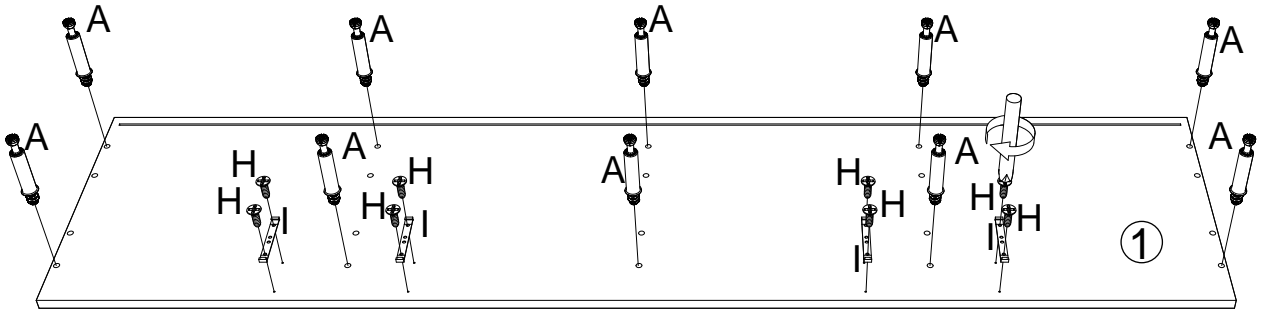
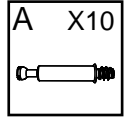
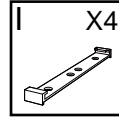
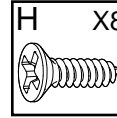
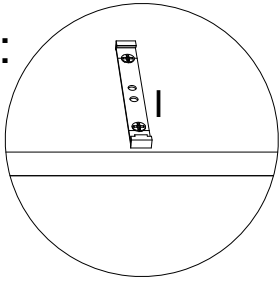

This position toward the front



This position toward the back



# STEP 2:

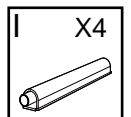
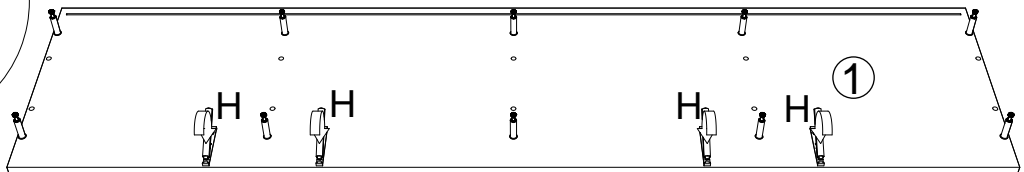
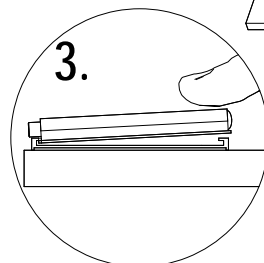
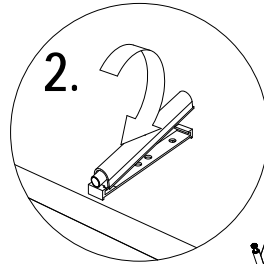
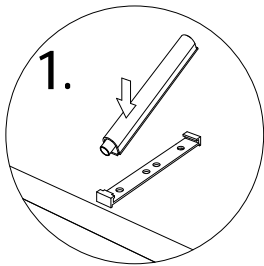

# STEP 3:

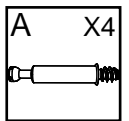
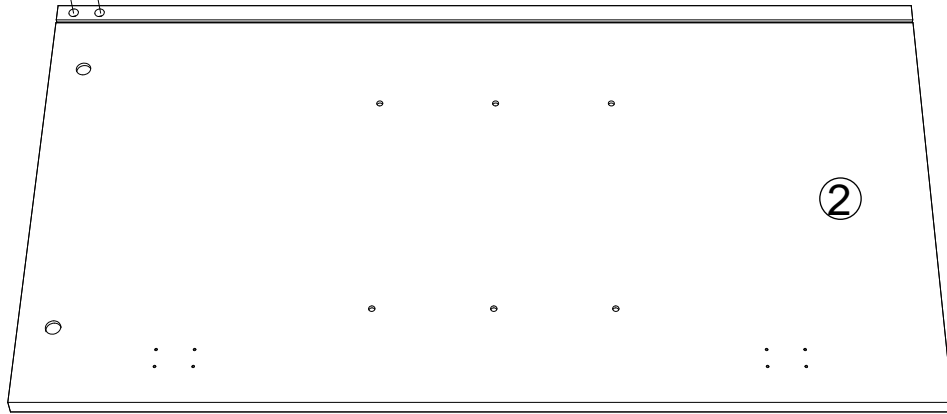
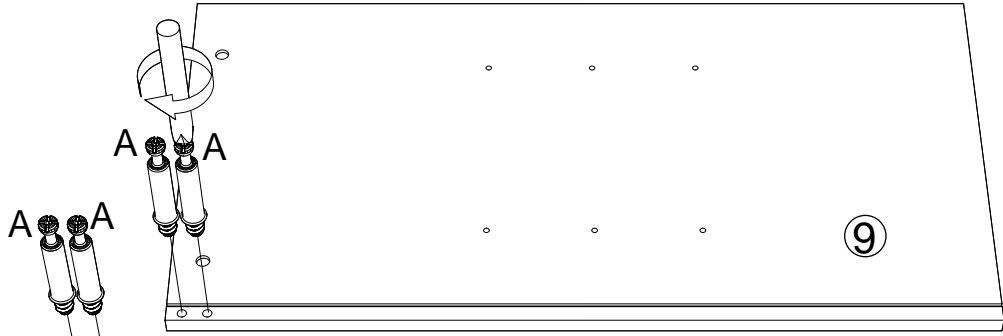

# STEP 4:

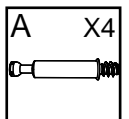
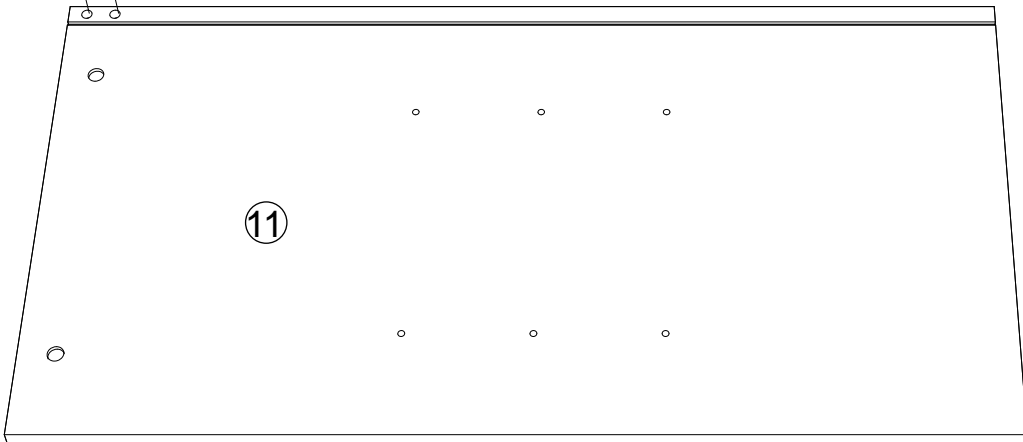
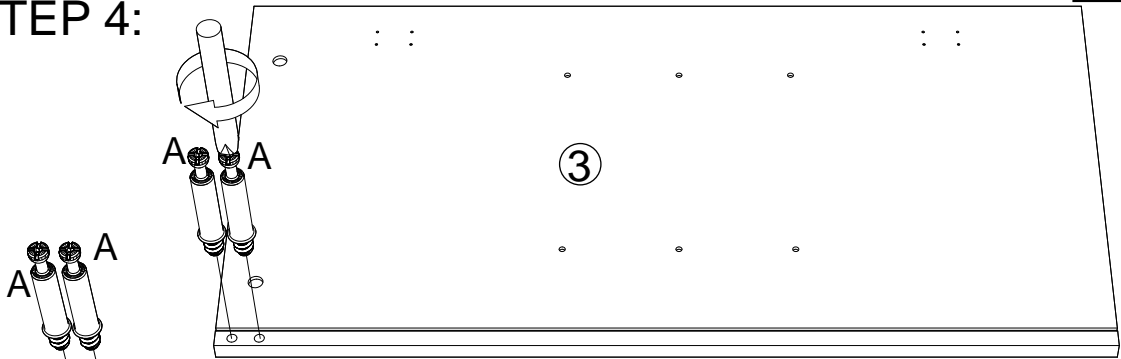

STEP 5:

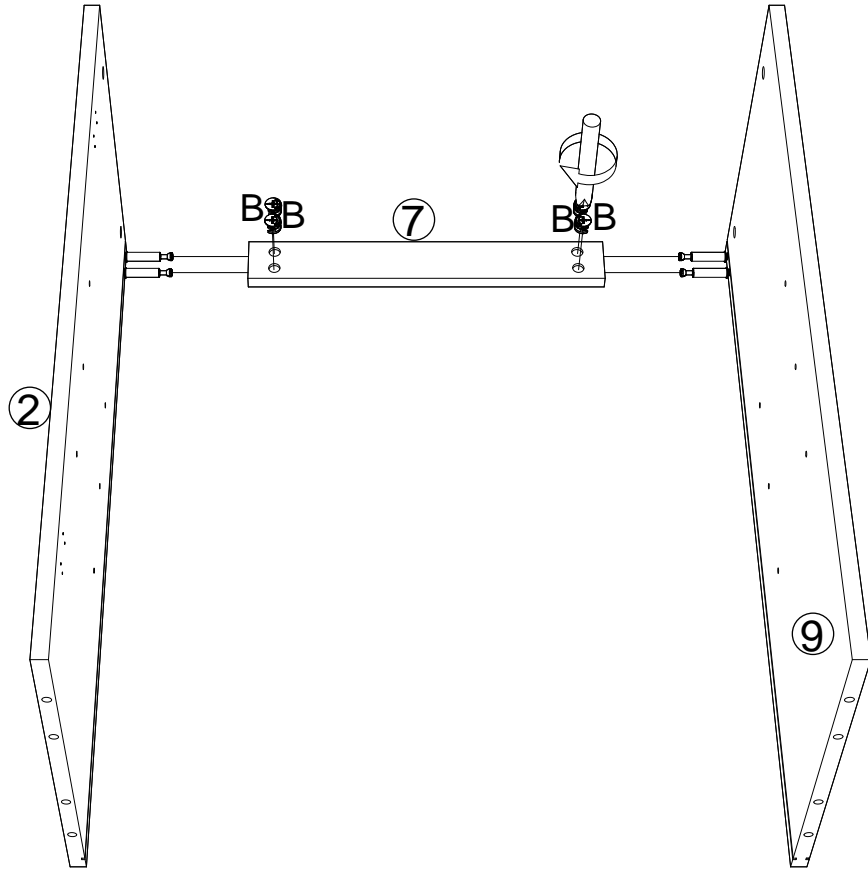

STEP 6:

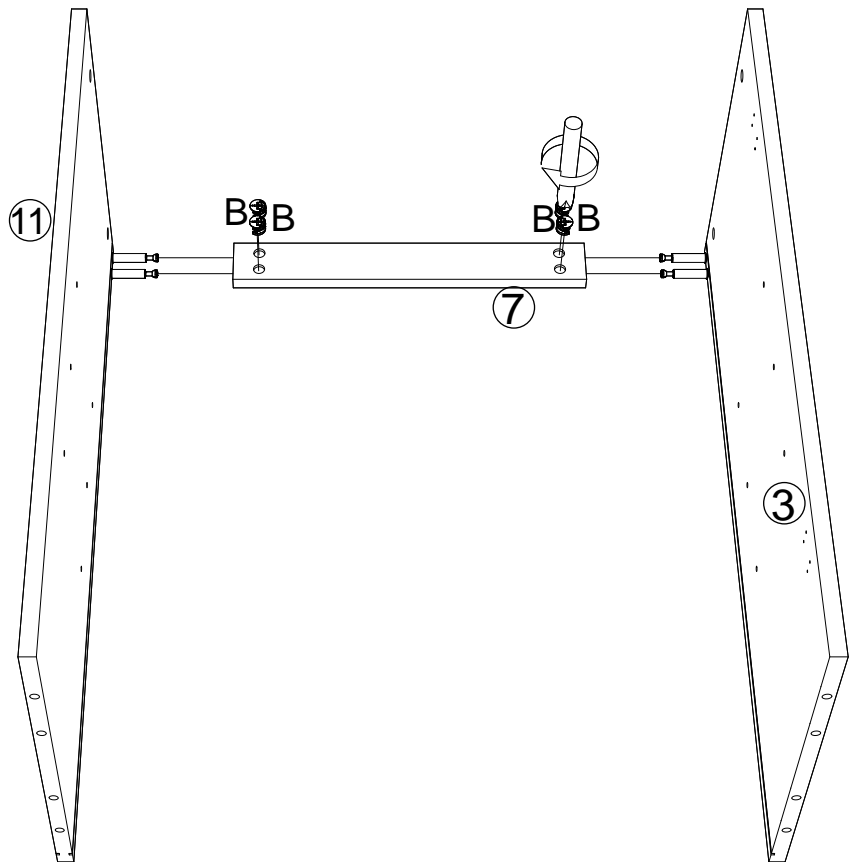

# STEP 7:

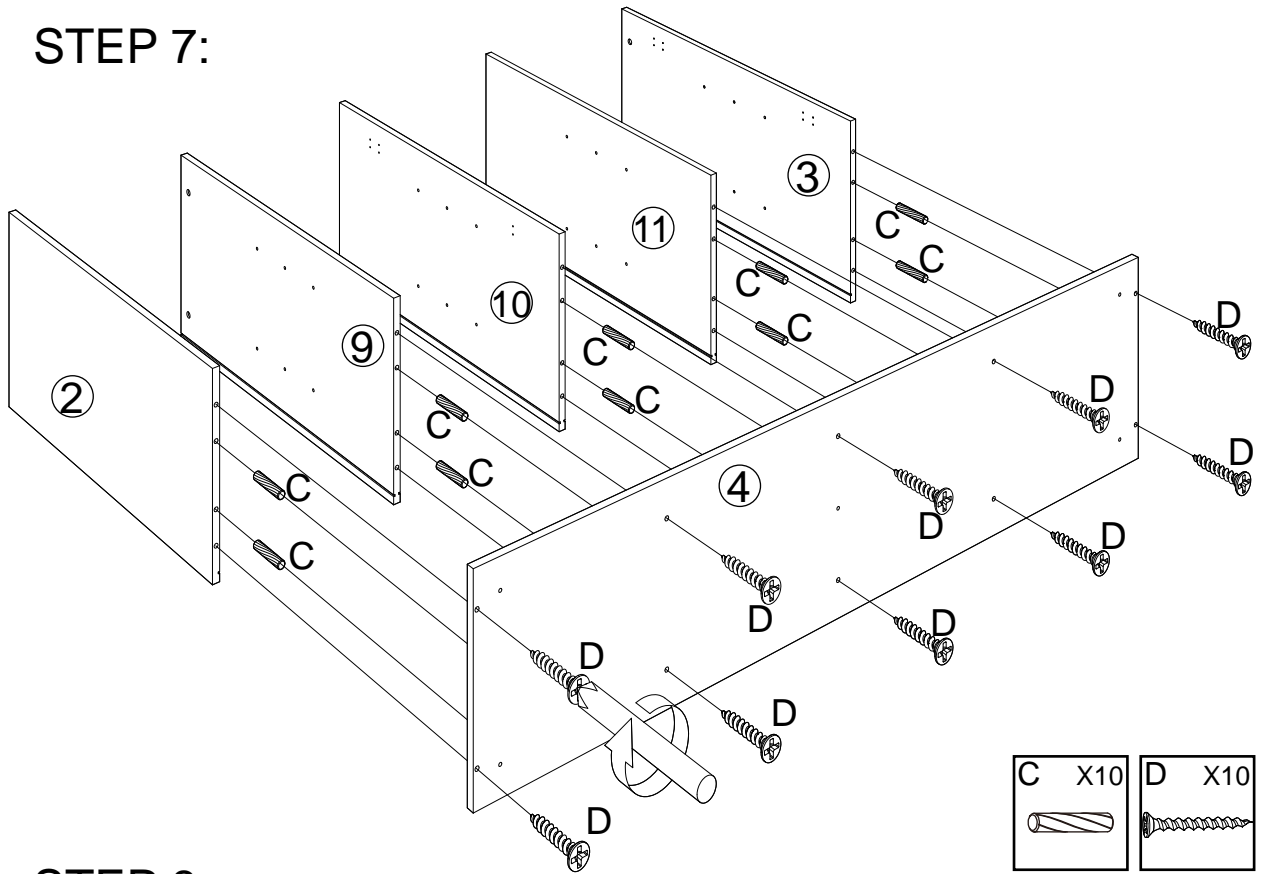

# STEP 8:

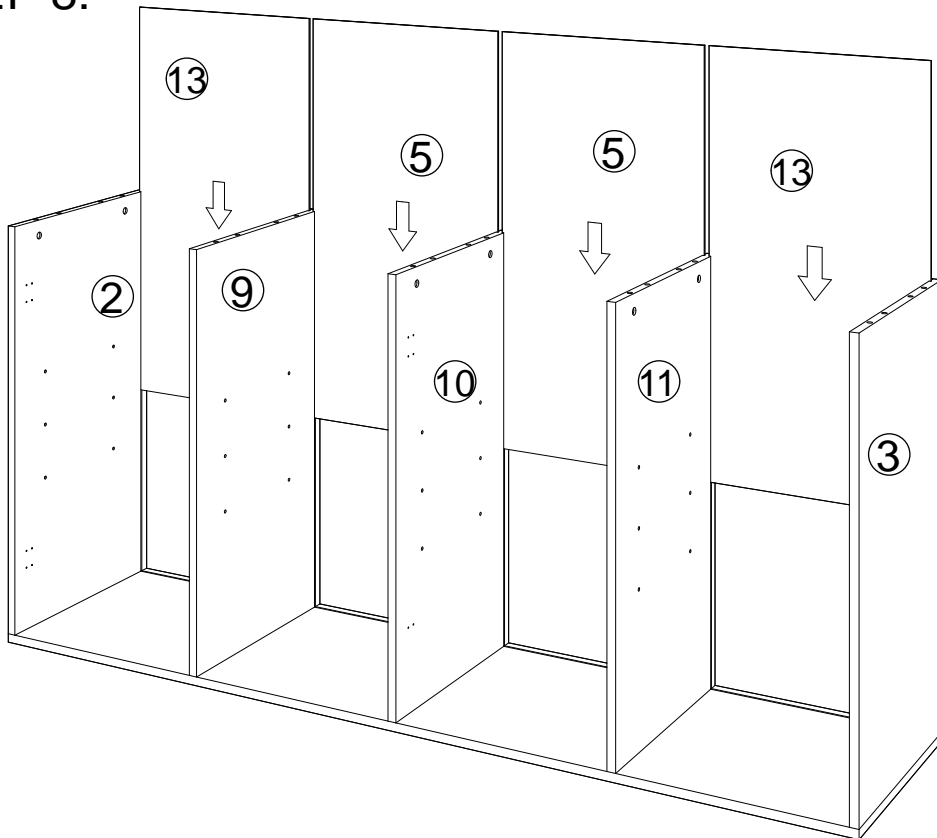

# STEP 9:

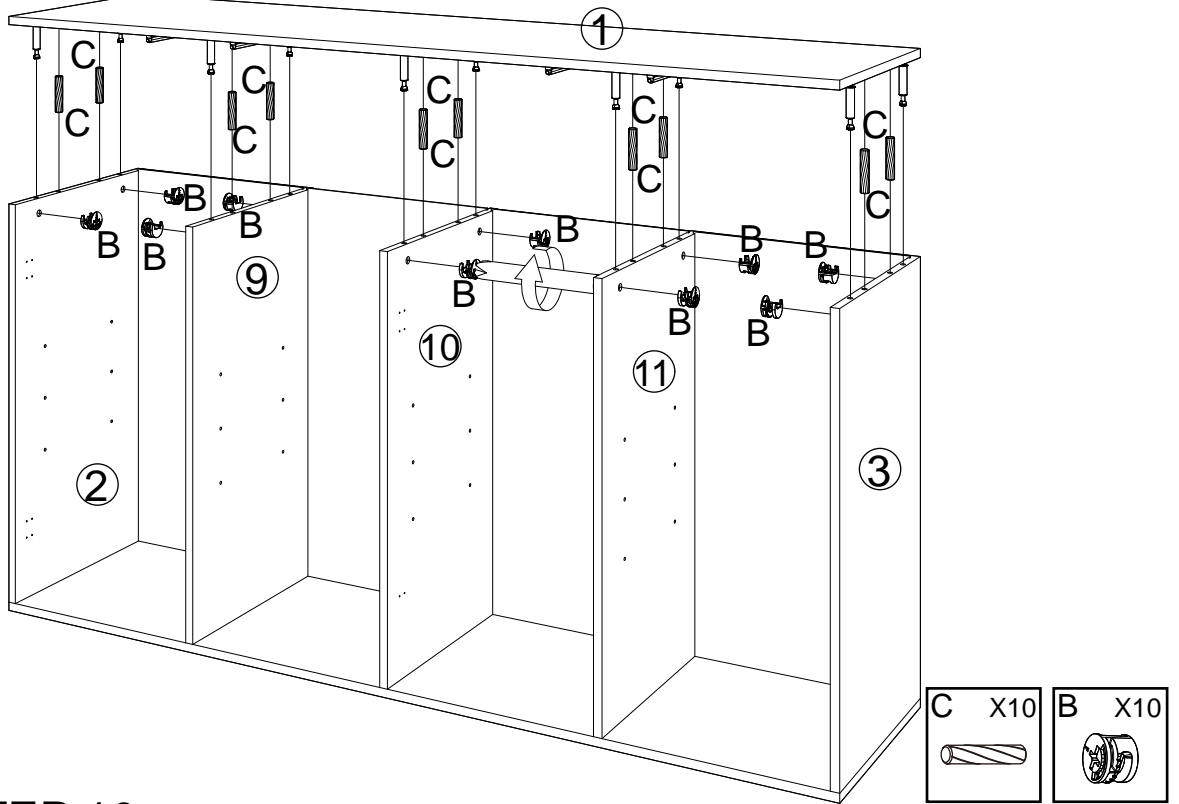

# STEP 10:

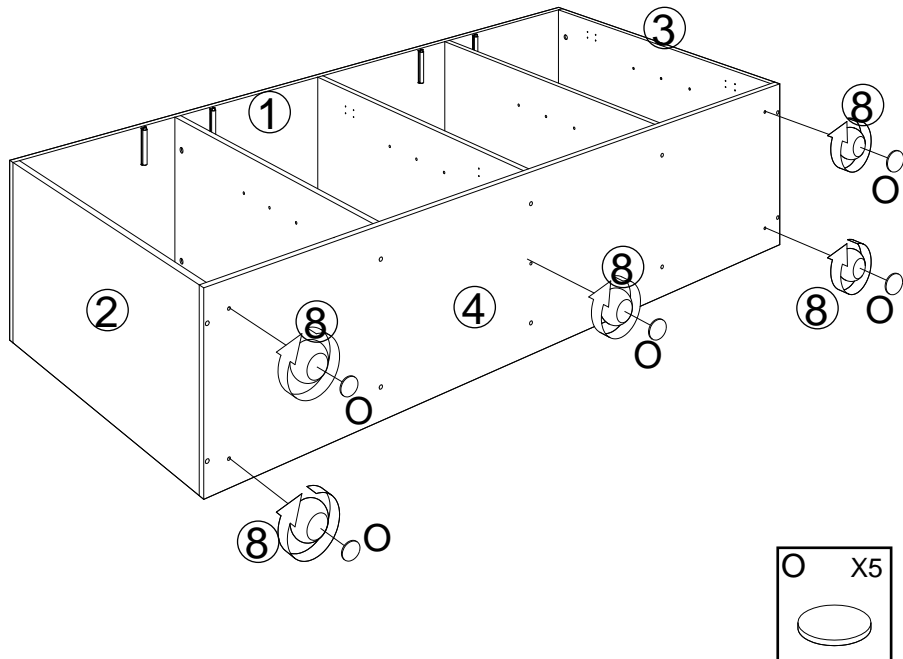
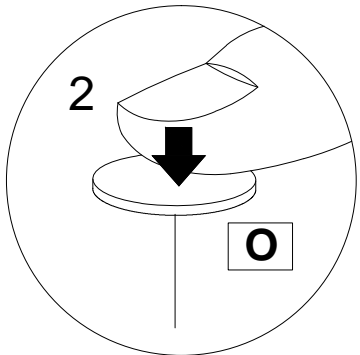
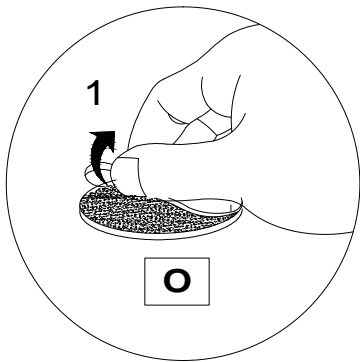

# STEP 11:

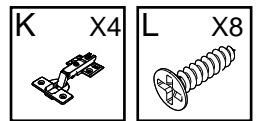
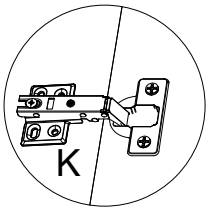
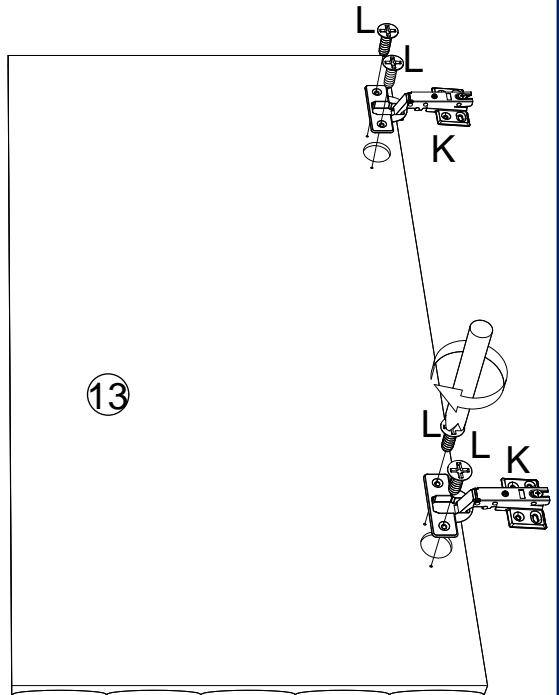
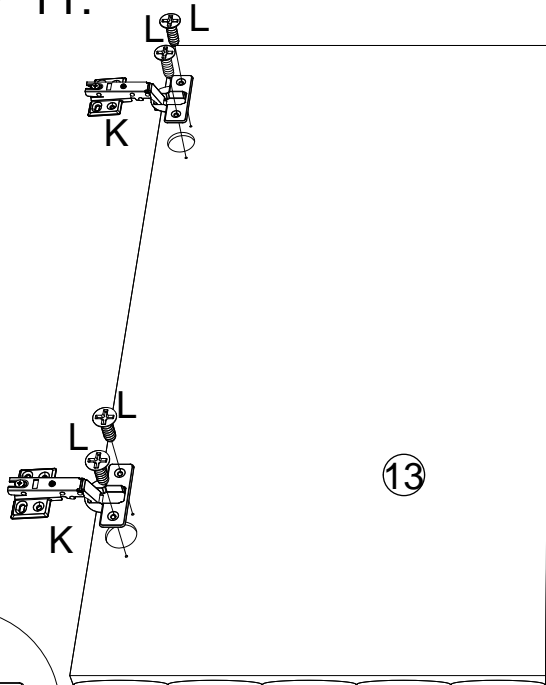

# STEP 12:

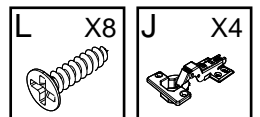
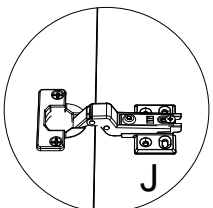
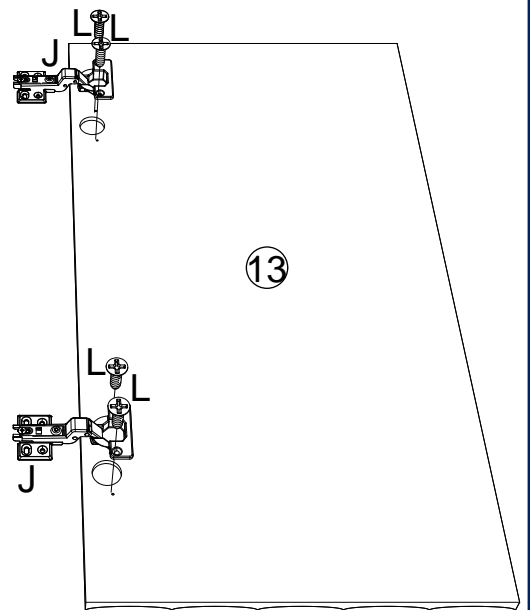
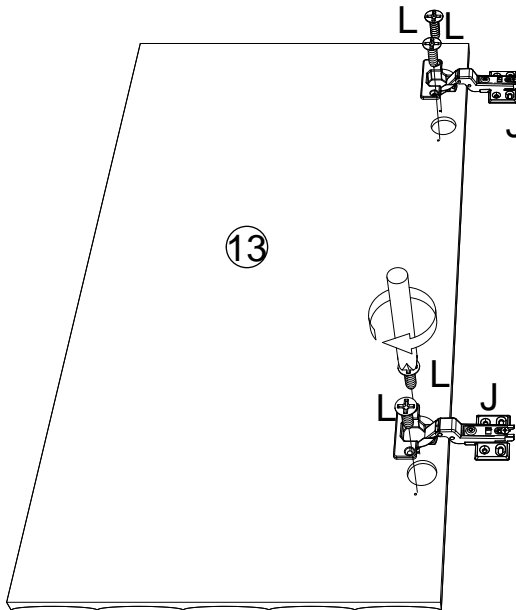

# STEP 13:

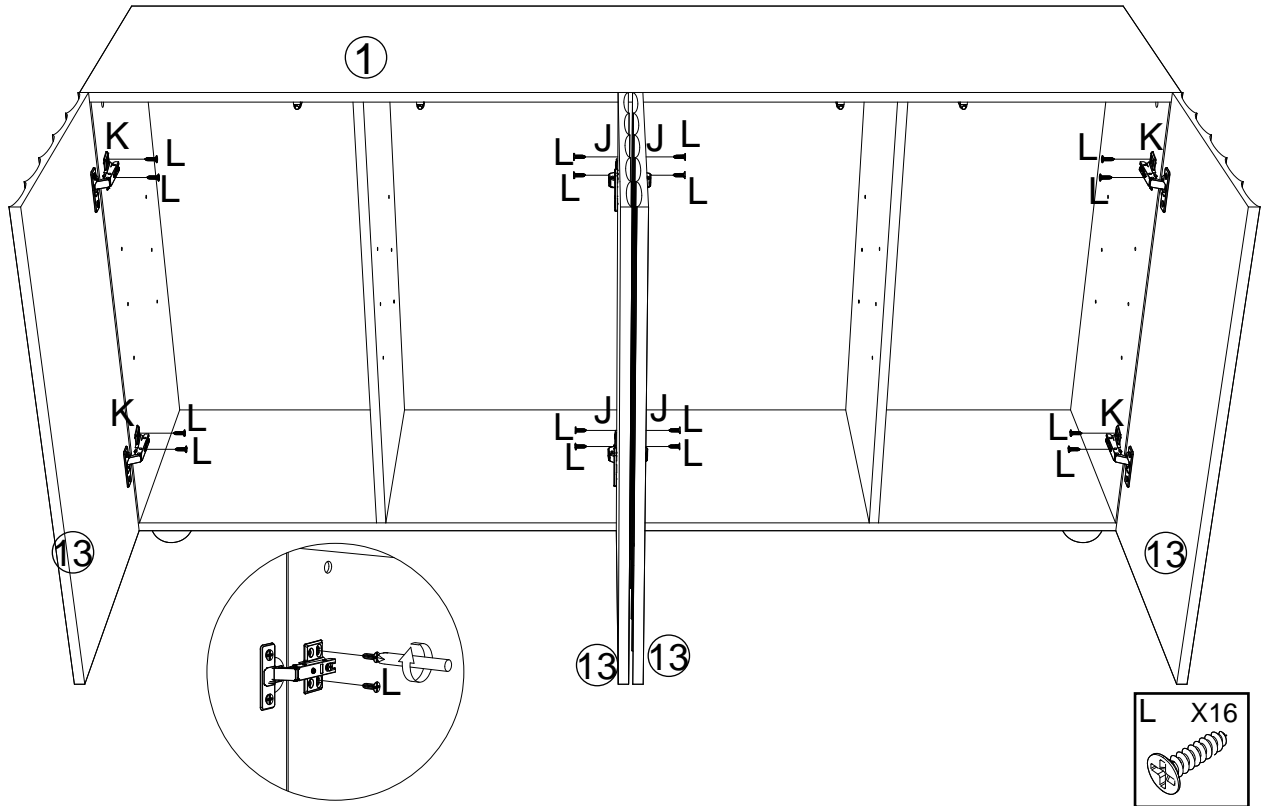

## INFORMATION

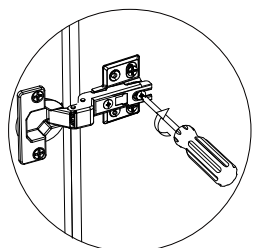
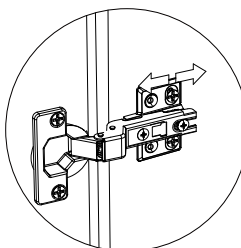
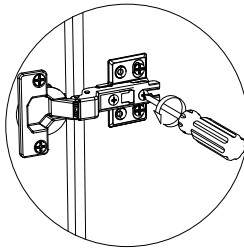
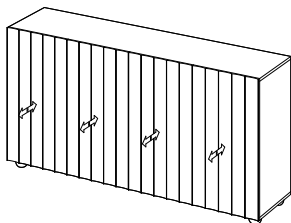
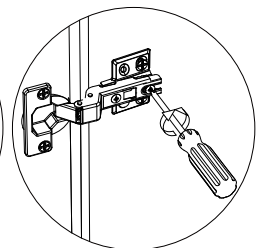
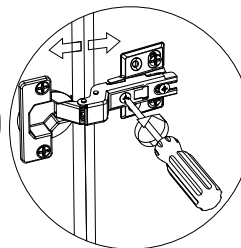
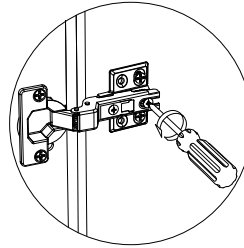
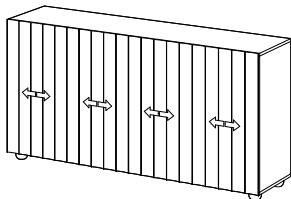
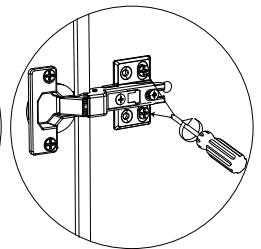
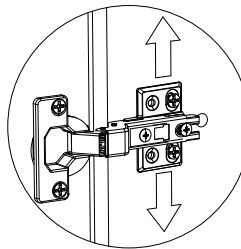
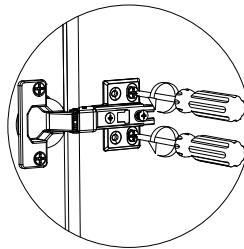
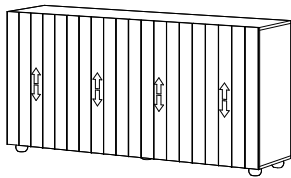

# STEP 14:

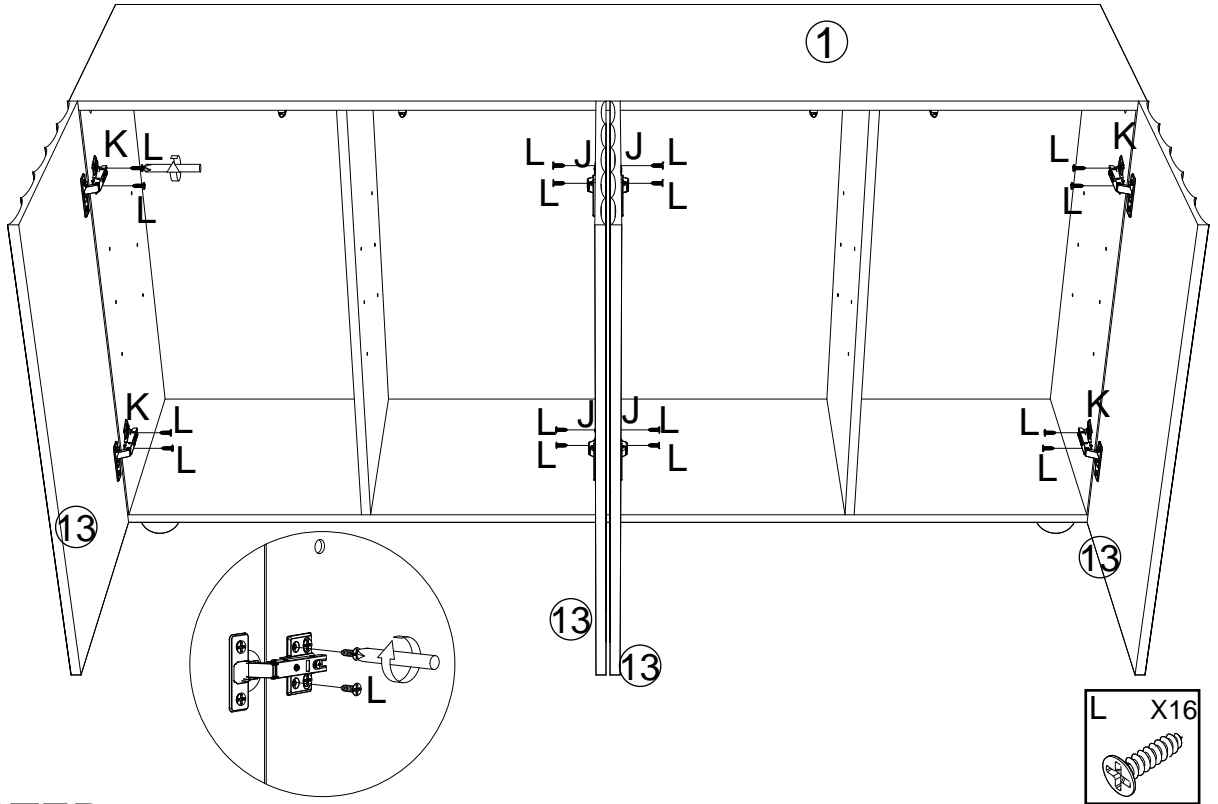

# STEP 15:

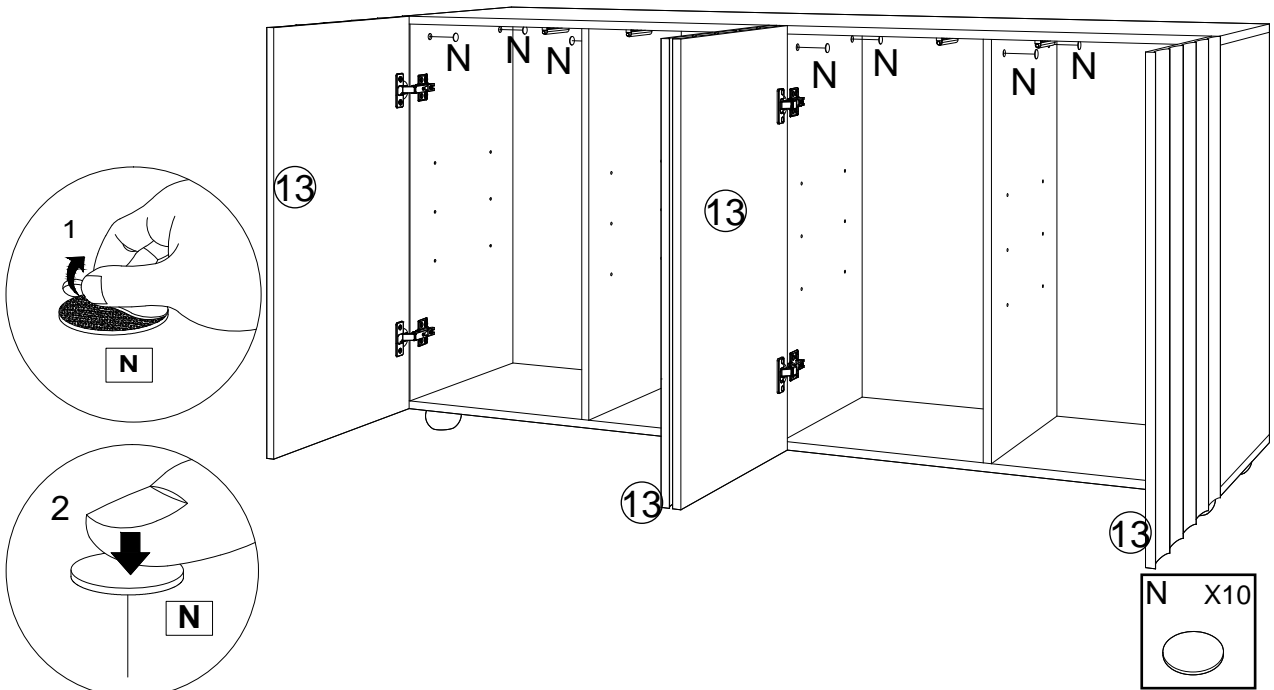

# STEP 16:

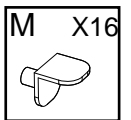
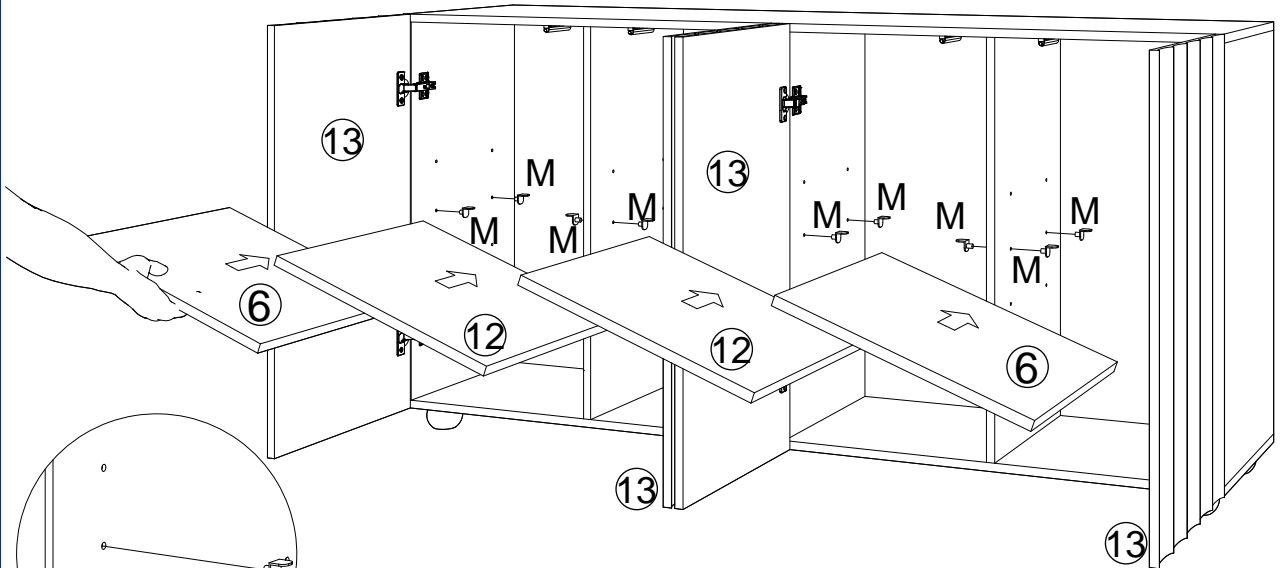

# STEP 17:

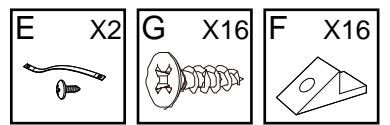
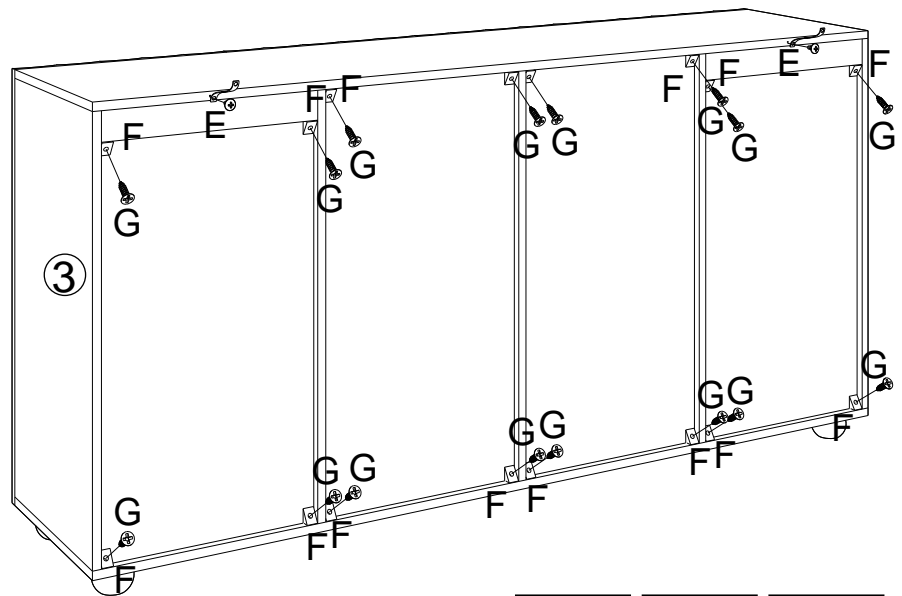

STEP 18:

# WALL

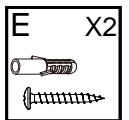
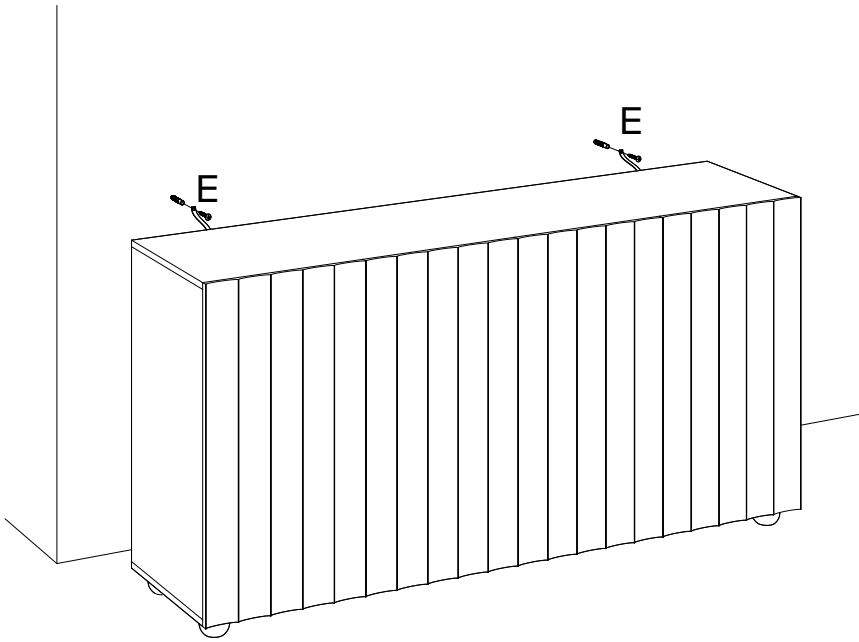
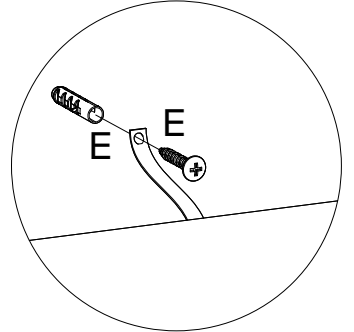
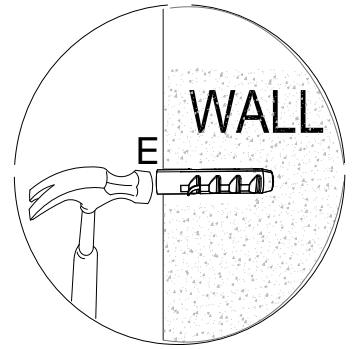

ASSEMBLY IS COMPLETE

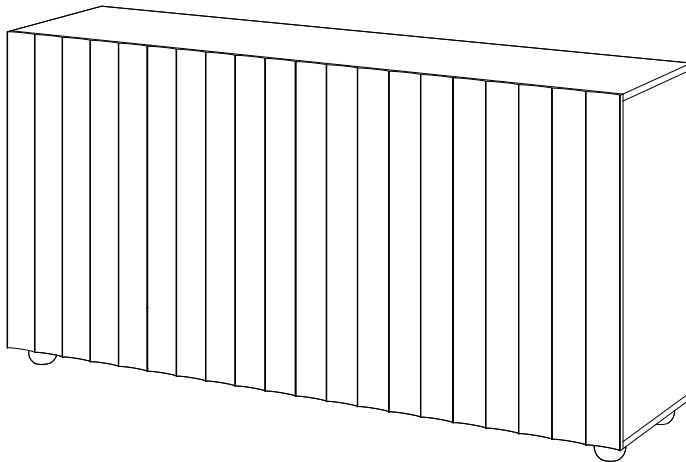

**DO NOT DRAG:**

Do not drag the item as this may cause damage to the legs.  
Instead, use 2 people to lift carefully and with caution from either end.

# SAFETY BRACKETS INSTRUCTIONS

1. Attach the strap to the furniture frame with the small screw.
2. Move the furniture to its final position. Attach the strap to the wall with the large screw. If mounting into brick or masonry you will need to acquire wall anchors.
3. Make sure that the strap is firmly attached to the wall and furniture and that the wall strap is snug.

## HARDWARE



Anti-tilt Strap X1



SCREWS X1



SCREWS X1



Expanded plastic pipe X1

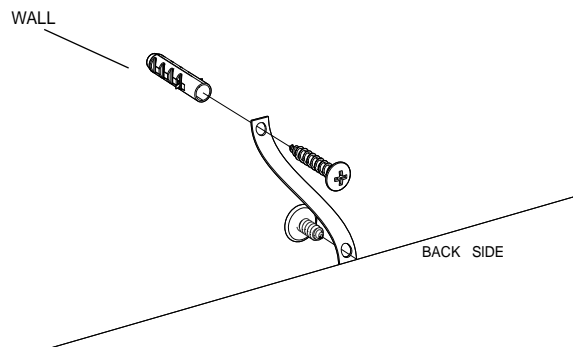

## **To protect your furniture, we suggest the following:**

- Avoid placing your furniture in direct sunlight.
- Do not place furniture directly under windows.
- Do not place sharp materials (knife, fork, etc.) directly onto your furniture as sharp material may scrape and damage the finish.
- Do not place material with high temperature directly onto the surface of your furniture.
- Clean up spills quickly. Water left over a prolonged period of time may cause damage. Alcohol, perfume, nail polishes, aftershave and some medication may cause severe finish damage if not cleaned immediately.
- Use a clean, soft, dry, lint free absorbent cloth to clean your furniture. Do not use any detergent as they may contain ingredients that may react and damage the finish.

**NOTE:** If the above care advise is not adhered to your product warranty may become void